

Title Zynqタイミング変調回路メイン基板		
Size A4	Number 824	Revision 1.0
Date: 11/25/2020	Sheet 1 of 3	
File: D:\MyDoc\...\TM_main.SchDoc	Drawn By: Yasuhiko Ito	

System Clocks in

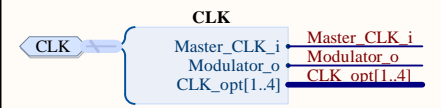

Trigger_input



LED out

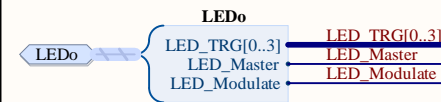

Test Port

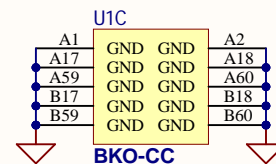
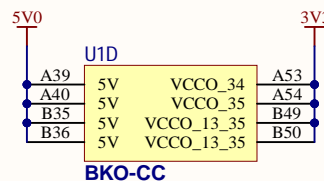
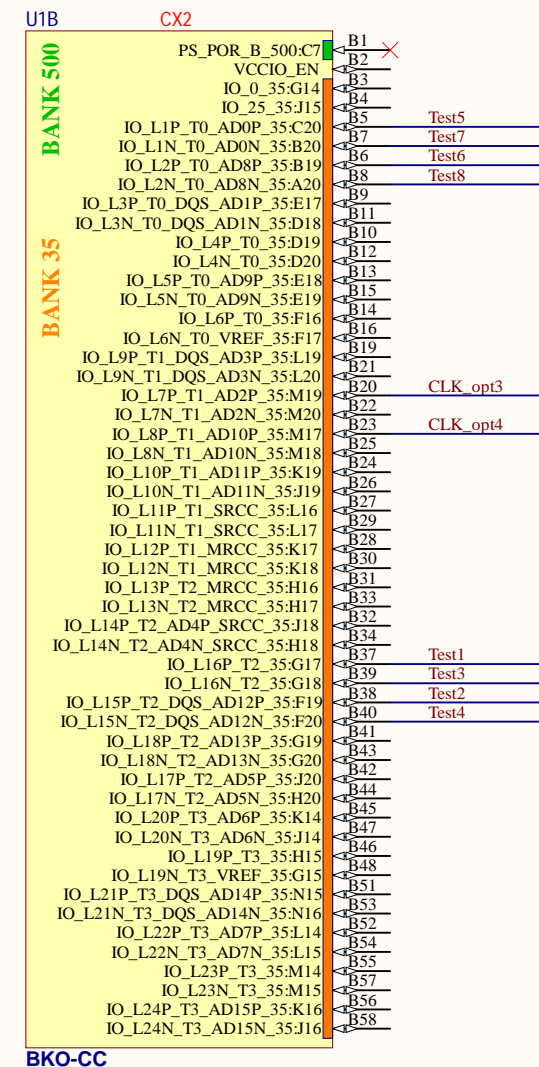
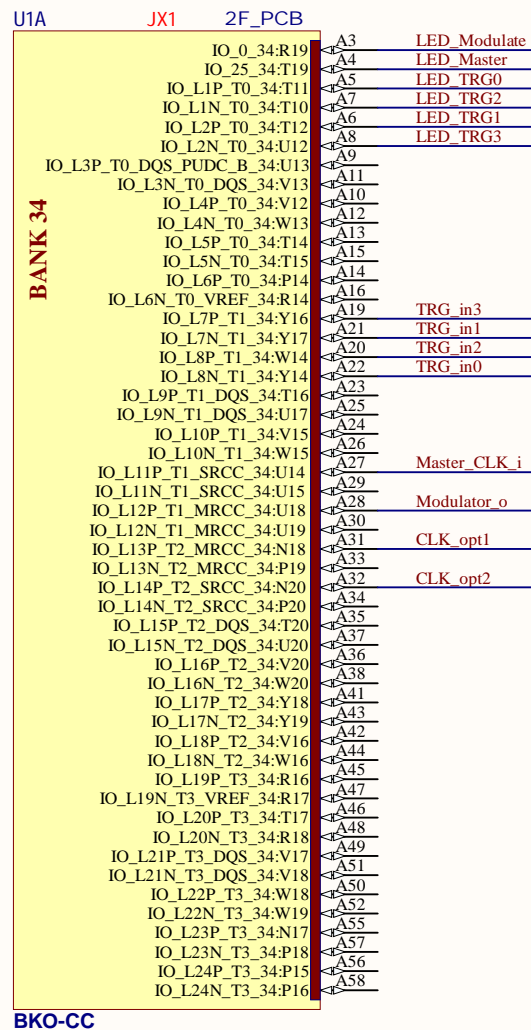
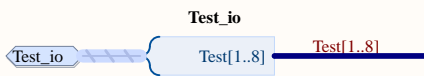

Title		
MicroZed Board		
Size	Number	Revision
A4	824	1.0
Date:	11/25/2020	Sheet:3 of 4
File:	D:\MyDoc\...\MicroZed.SchDoc	Drawn By: Yasuhiko Ito

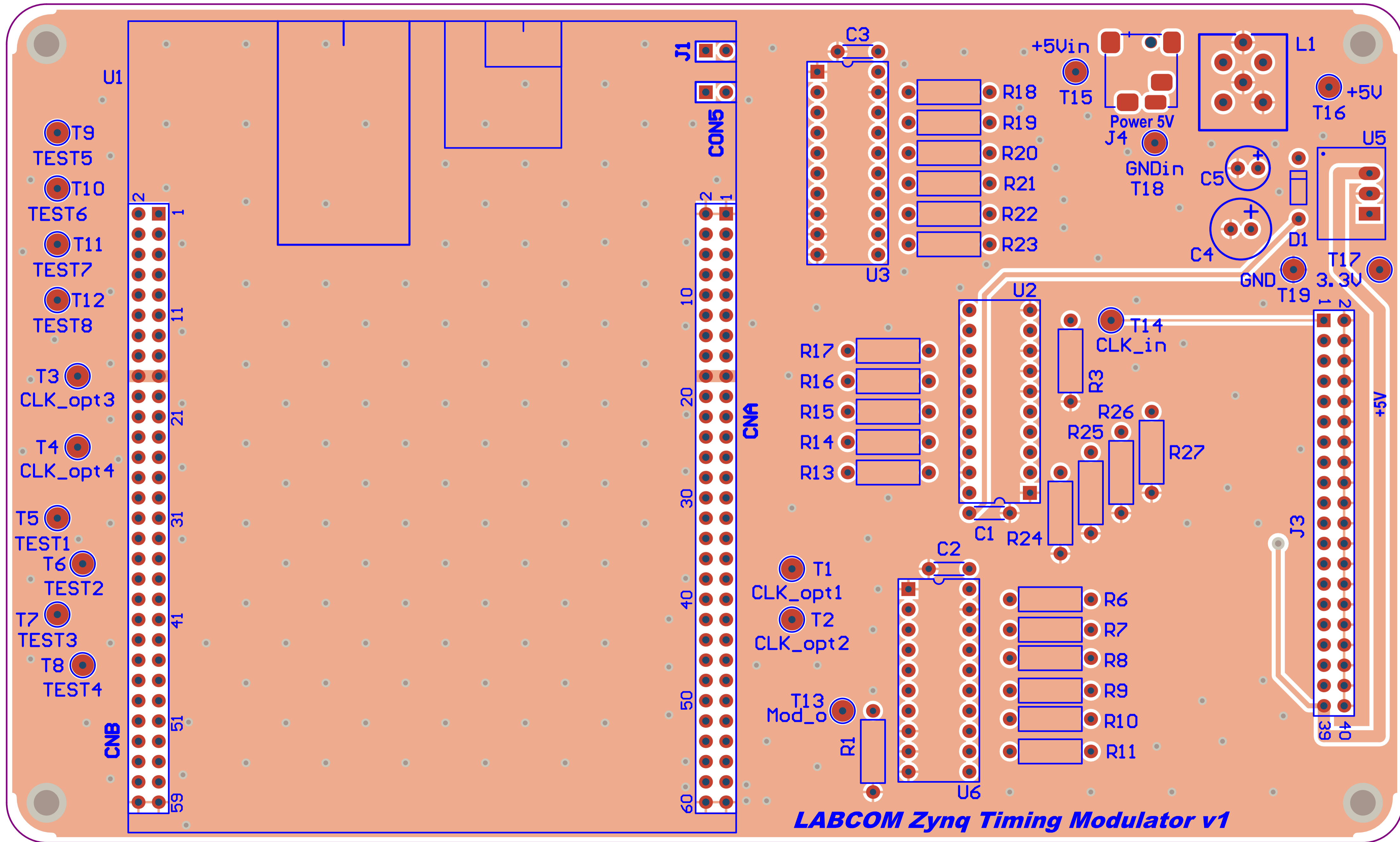

LABCOM Zynq Timing Modulator v1

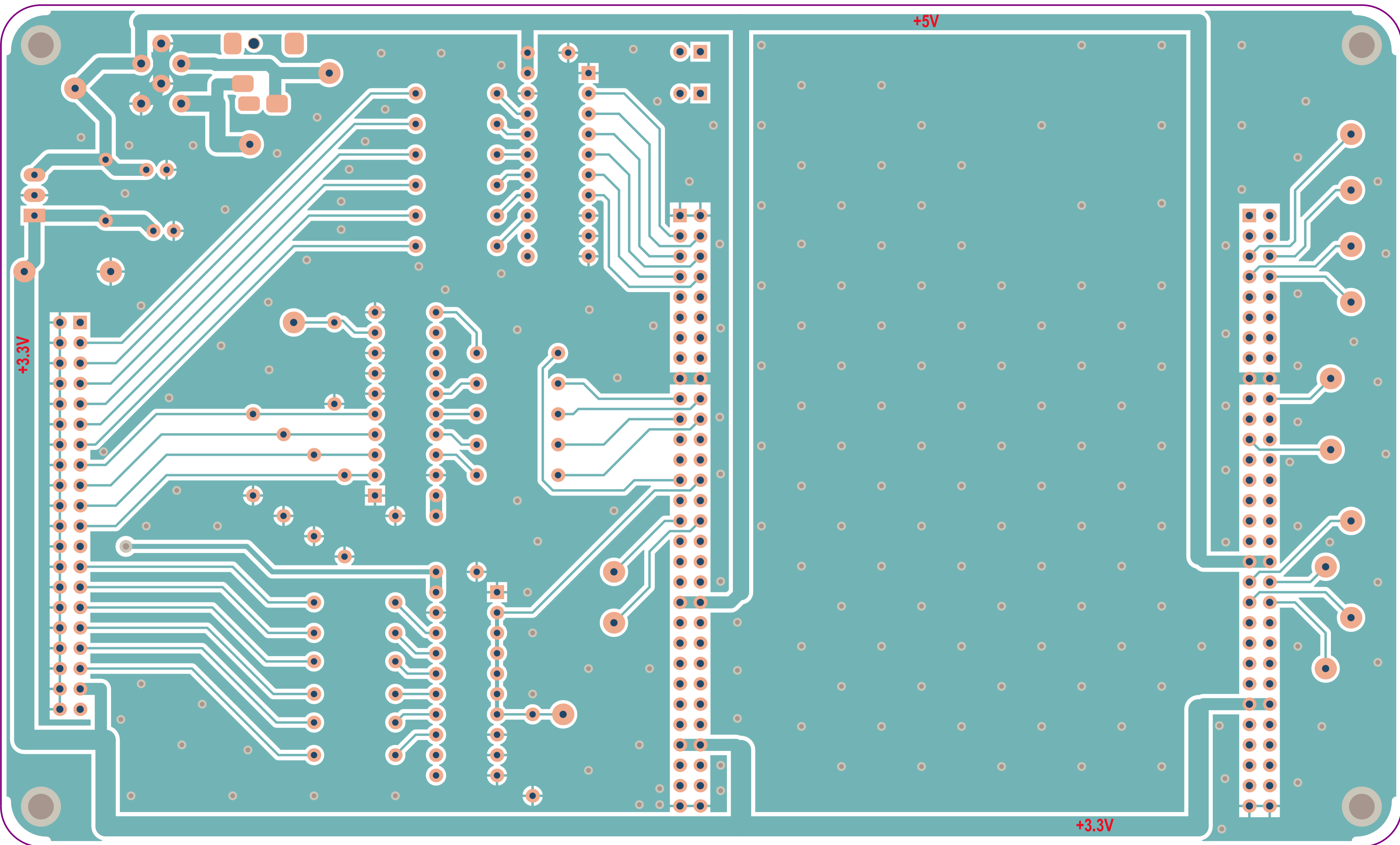

+5V

+3.3V

+3.3V